

ASSEMBLY INSTRUCTIONS --WPD11



HELP LINE
0800 0126777

A  UPRIGHTS X 8

B  LONG BEAMS X 10

C  SIDE BEAMS X 10

D  PLASTIC FEET X 8
G.  UPRIGHT CONNECTORS x 4

E  5x MDF BOARDS

F  CENTRAL SUPPORT X 5

i **Information**
if in doubt contact the supplier

 Please read these instructions thoroughly before commencing assembly.

 Inspect all packages for damage and check that all components have been supplied

 Assembly should be undertaken by at least two people

! **Caution**
During Assembly

 Wear appropriate clothing - protective gloves and footwear are recommended

 Dispose of packaging materials responsibly

 Make sure the floor is level

 Allow adequate working space and be aware of others working around you

 Take care when handling heavy items particularly when lifting or stretching

! **Warning**
Rules for safe use of shelving

 Not suitable for use in damp or wet environments.

 ENSURE THAT THE MAXIMUM LOAD CARRYING CAPACITIES ARE NOT EXCEEDED

 Shelves must be loaded evenly and load heavier items on the bottom shelves

 Never climb or stand on the shelves.

TOOLS REQUIRED



RUBBER Mallet

Shelving Bay Assembly

- 1.** Slot first beam into upright. Tap into place with a rubber mallet at the desired level. Push plastic protective feet onto the bottom of the uprights

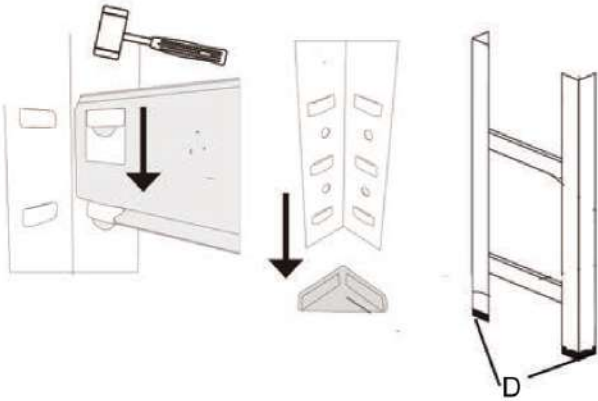

- 2.** Assemble end frames with short side beams and add long front and back beams to join the frames together.

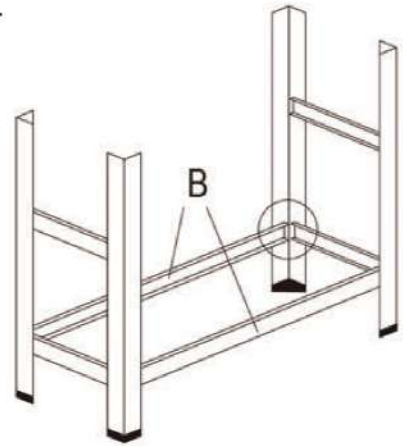

- 3.** Slot the centre support beam into front and back beams.

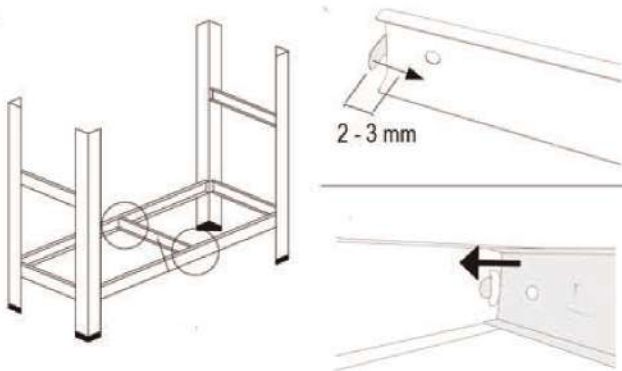

- 4.** Slot upright connector into top of lower upright. Push top into place or tap down with mallet if necessary.

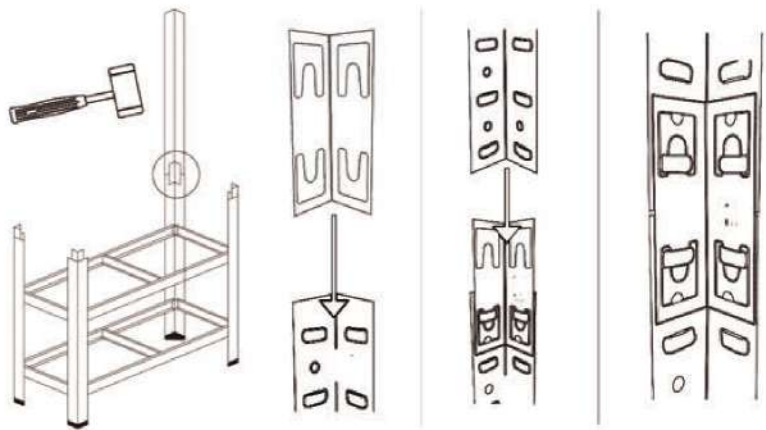

- 5.** Repeat steps 2 and 3 to add the remaining levels. Insert MDF boards at an angle, corners first.

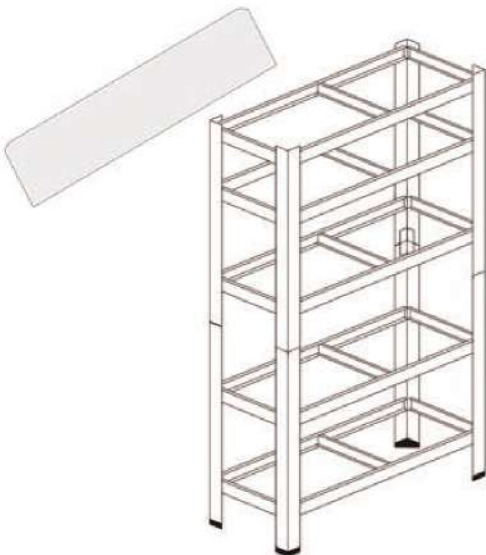

- 6.** Push remaining plastic protective caps on the top of the uprights.

