**Warm Suggestion**

Before installation, the mirror surface is protected by a layer of film. Please remove it when you are sure that all of the parts have been installed well!

**Installation Steps****Step 1:**

Fix the Right and Left L'Parts to the back of mirror with bolts, assure that the arc hole is down.

**Step 2:**

Drill three proper positioned holes in the wall for installation, join the Brackets and Wall Part together with M10 Bolts, and then connect them to the wall.

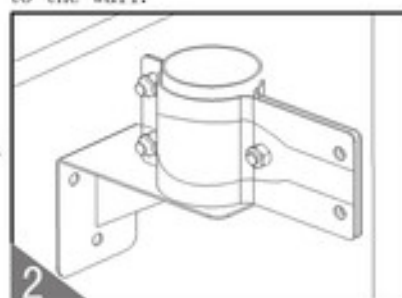
**Step 3:**

Connect the L'Parts fixed into the mirror back to the Brackets with M10 Bolts, adjust the angle and position well, then screw them.

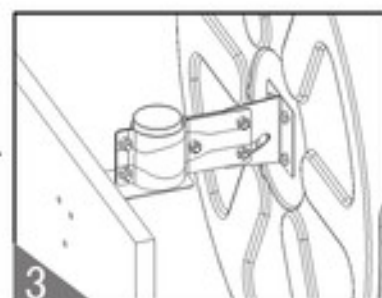
**Caution**

(1)Periodical clean:After a term the mirror must be cleaned carefully by a soft cloth damped with water, then dry it with cotton or soft tissue;The PC mirror should be cleaned by water and then air-dry it spontaneously.  
 (2)Precaution:Prohibit using any escharotic or ammoniate on the mirror surface. (3)The final product is standard.

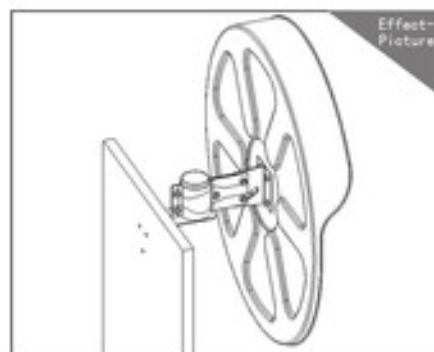
**Warm Suggestion**

Before installation, the mirror surface is protected by a layer of film. Please remove it when you are sure that all of the parts have been installed well!

**Installation Steps****Step 1:**

Fix the Right and Left L'Parts to the back of mirror with bolts, assure that the arc hole is down.

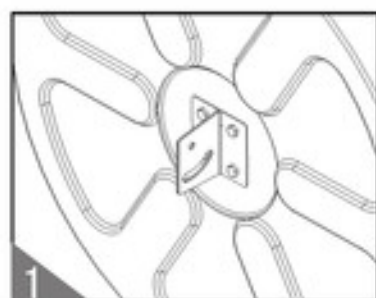
**Step 2:**

Drill three proper positioned holes in the wall for installation, join the Brackets and Wall Part together with M10 Bolts, and then connect them to the wall.

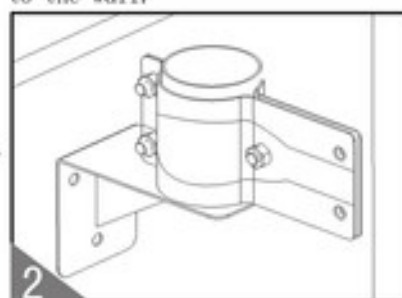
**Step 3:**

Connect the L'Parts fixed into the mirror back to the Brackets with M10 Bolts, adjust the angle and position well, then screw them.

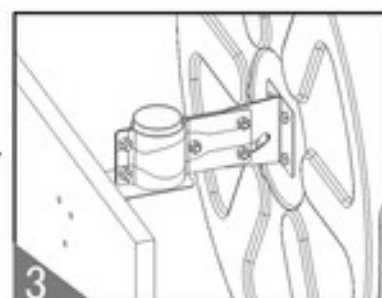
**Caution**

(1)Periodical clean:After a term the mirror must be cleaned carefully by a soft cloth damped with water, then dry it with cotton or soft tissue;The PC mirror should be cleaned by water and then air-dry it spontaneously.  
 (2)Precaution:Prohibit using any escharotic or ammoniate on the mirror surface. (3)The final product is standard.