

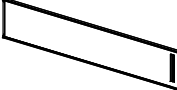

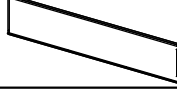





Part ID	Description	Illustration	Qty
A	Left Side Panel		1
B	Right Side Panel		1
C	Rear Wall		1
D	Front Piece		1
E	Top		1
F	Bottom		1
G	Shelf		4
H	Screw		10
I	Shelf Support		16

ASSEMBLE INSTRUCTION

1. Link A, B with D

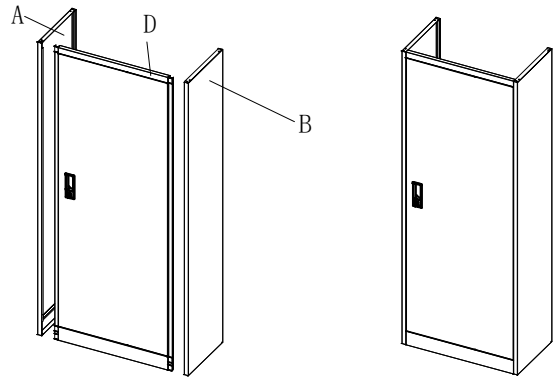

2. Link C with A, B
fix by H

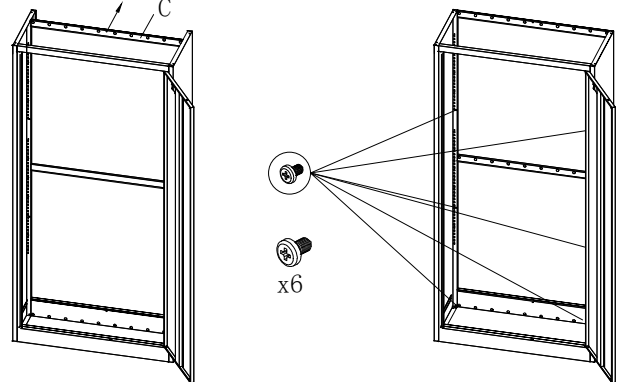

3. Install E into body of cabinet
fix by H

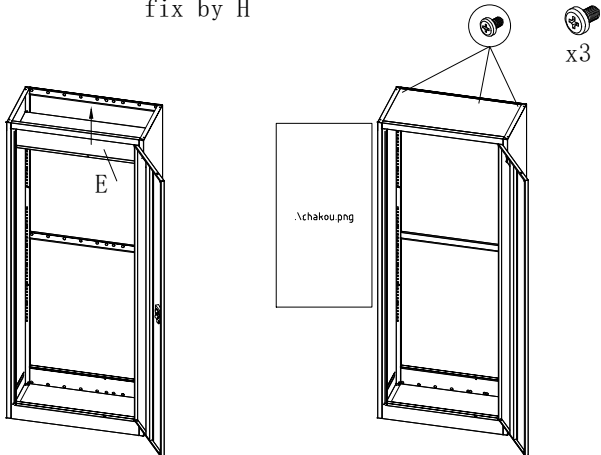

5. Install I into body of cabinet,
as shown in the following figure

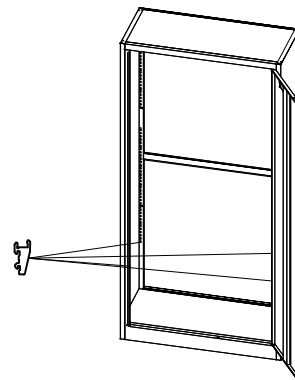

4. Install F into body of cabinet
fix by H

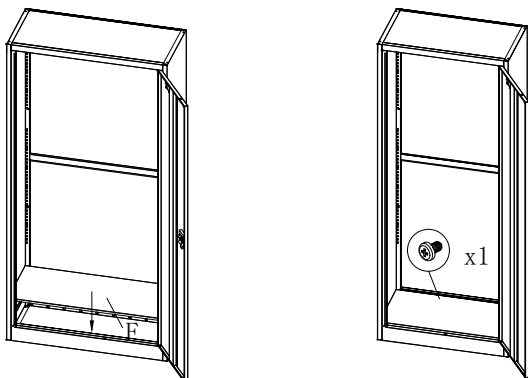

6. Install G into body of cabinet

